

GasAlertMicro5

GasAlertMicro5 PID

GasAlertMicro5 IR

1, 2, 3, 4, and 5-Gas Detector

Quick Reference Guide

BW
Technologies
by Honeywell

Limited Warranty and Limitation Liability

BW Technologies LP (BW) warrants the product to be free from defects in material and workmanship under normal use and service for a period of two years, beginning on the date of shipment to the buyer. This warranty extends only to the sale of new and unused products to the original buyer. BW's warranty obligation is limited, at BW's option, to refund of the purchase price, repair or replacement of a defective product that is returned to a BW authorized service center within the warranty period. In no event shall BW's liability hereunder exceed the purchase price actually paid by the buyer for the Product.

This warranty does not include:

- a) fuses, disposable batteries or the routine replacement of parts due to the normal wear and tear of the product arising from use;
- b) any product which in BW's opinion, has been misused, altered, neglected or damaged, by accident or abnormal conditions of operation, handling or use;
- c) any damage or defects attributable to repair of the product by any person other than an authorized dealer, or the installation of unapproved parts on the product; or

The obligations set forth in this warranty are conditional on:

- a) proper storage, installation, calibration, use, maintenance and compliance with the product manual instructions and any other applicable recommendations of BW;
- b) the buyer promptly notifying BW of any defect and, if required, promptly making the product available for correction. No goods shall be returned to BW until receipt by the buyer of shipping instructions from BW; and
- c) the right of BW to require that the buyer provide proof of purchase such as the original invoice, bill of sale or packing slip to establish that the product is within the warranty period.

THE BUYER AGREES THAT THIS WARRANTY IS THE BUYER'S SOLE AND EXCLUSIVE REMEDY AND IS IN LIEU OF ALL OTHER WARRANTIES, EXPRESS OR IMPLIED, INCLUDING BUT NOT LIMITED TO ANY IMPLIED WARRANTY OF MERCHANTABILITY OR FITNESS FOR A PARTICULAR PURPOSE. BW SHALL NOT BE LIABLE FOR ANY SPECIAL, INDIRECT, INCIDENTAL, OR BASED ON CONTRACT, TORT OR RELIANCE OR ANY OTHER THEORY.

Since some countries or states do not allow limitation of the term of an implied warranty, or exclusion or limitation of incidental or consequential damages, the limitations and exclusions of this warranty may not apply to every buyer. If any provision of this warranty is held invalid or unenforceable by a court of competent jurisdiction, such holding will not affect the validity or enforceability of any other provision.

Contacting BW Technologies by Honeywell

USA: 1-888-749-8878

Canada: 1-800-663-4164

Europe: +44(0) 1295 700300

Other countries: +1-403-248-9226

Email us at: info@gasmonitors.com

Visit BW Technologies by Honeywell's website at: www.gasmonitors.com

GasAlertMicro 5/PID/IR

Introduction

The quick reference guide provides basic information to operate the GasAlertMicro 5, GasAlertMicro 5 PID, and GasAlertMicro 5 IR gas detectors. For complete operating instructions, refer to the *GasAlertMicro 5/PID/IR User Manual* provided on the CD-ROM.

The GasAlertMicro 5, GasAlertMicro 5 PID, and GasAlertMicro 5 IR detectors (“the detector”) are designed to warn of hazardous gas levels above user-defined alarm setpoints.

Note

Unless reference is made to a specific detector model, the GasAlertMicro 5, GasAlertMicro 5 PID, and GasAlertMicro 5 IR detectors are referred to as GasAlertMicro 5/PID/IR.

Note

The detector is shipped with English as the default displayed language. Additional languages provided are French, German, Spanish, and Portuguese. The screens for the additional languages are displayed on the detector and in the corresponding quick reference guide.

Safety Information - Read First

Use the detector only as specified in this quick reference guide and the user manual, otherwise the protection provided by the detector may be impaired.

The detector is a personal safety device. It is your responsibility to respond properly to the alarm.

Read the following **Cautions** before using the detector.

⚠ Cautions

- **Warning:** Substitution of components may impair Intrinsic Safety.
- **Caution:** For safety reasons, this equipment must be operated and serviced by qualified personnel only. Read and understand the user manual completely before operating or servicing.
- Charge the detector before first-time use. BW recommends the detector be charged after every workday.
- Charge the battery pack immediately when a low battery alarm occurs.
- Read and adhere to the battery cautions provided in [Replacing Battery Cells and Packs on page 17](#).
- BW recommends that the combustible sensor be checked with a known concentration of calibration gas after any exposure to contaminants/poisons such as sulfur compounds, silicon vapors, halogenated compounds, etc.
- BW recommends to bump test the sensors before each day's use to confirm their ability to respond to gas by exposing the detector to a gas concentration that exceeds the alarm setpoints. Manually verify that the audible and visual alarms are activated. Calibrate if the readings are not within the specified limits.
- Calibrate the detector before first-time use and then on a regular schedule, depending on use and sensor exposure to poisons and contaminants. The sensors must be calibrated regularly and at least once every 180 days (6 months).
- Calibrate only in a safe area that is free of hazardous gas in an atmosphere of 20.9% oxygen.

- Only the combustible gas detection portion of this instrument has been assessed for performance by CSA International.
- The combustible sensor is factory calibrated to 50% LEL methane. If monitoring a different combustible gas in the % LEL range, calibrate the sensor using the appropriate gas.
- **Caution:** High off-scale LEL readings may indicate an explosive concentration.
- Protect the combustible sensor from exposure to lead compounds, silicones, and chlorinated hydrocarbons. Although certain organic vapors (such as leaded gasoline and halogenated hydrocarbons) may temporarily inhibit sensor performance, in most cases, the sensor will recover after calibration.
- For use only in potentially explosive atmospheres where oxygen concentrations do not exceed 20.9% (v/v).
- Any rapid up scaling reading followed by a declining or erratic reading may indicate a gas concentration beyond upper scale limit, which can be hazardous.
- Extended exposure of the GasAlertMicro 5, GasAlertMicro 5 PID, or GasAlertMicro 5 IR to certain concentrations of combustible gases and air may stress the detector element that can seriously affect its performance. If an alarm occurs due to a high concentration of combustible gases, recalibration should be performed, or if needed, the sensor replaced.
- The BW pump module (M5-PUMP) is certified for use with the GasAlertMicro 5, GasAlertMicro 5 PID, and GasAlertMicro 5 IR models only.

- **Protect the PID sensor from exposure to silicone vapors.**
- **When calibrating O₃ and ClO₂ sensors that are located in the Toxic 2 position of the detector, a single gas calibration cap must be used to ensure accurate calibration.**
- **Replace the CO₂ sensor only in a safe area that is free of hazardous gas in an atmosphere of 20.9% oxygen.**
- **Warning:** The battery pack (M5-BAT08) is equipped with a lithium battery that may present a risk of fire or chemical burn hazard if misused. Do not disassemble, heat above 212°F (100°C), or incinerate.
- **Warning:** Do not use any other lithium batteries that are not designed for use with the GasAlertMicro 5, GasAlertMicro5 PID, or GasAlertMicro5 IR detectors. Use of any other cell can cause fire and/or explosion. To order and replace the M5-BAT07 or the M5IR-BAT08 lithium battery pack, contact BW Technologies by Honeywell.
- **Warning:** Lithium polymer cells exposed to heat at 266°F (130°C) for 10 minutes can cause fire and/or explosion.
- **Dispose of used lithium cells immediately. Do not disassemble and do not dispose of in fire. Do not mix with the solid waste stream. Spent batteries must be disposed of by a qualified recycler or hazardous materials handler.**
- **Keep lithium cells away from children.**
- **Before using common products around sensors, refer to [Sensor Poisons and Contaminants on page 4](#).**

The detector contains either alkaline batteries or a lithium polymer battery. Refer to the following warnings.

 **Warning**

This instrument contains alkaline batteries. Do not mix with the solid waste stream. Spent batteries must be disposed of by a qualified recycler or hazardous materials handler.

 **Warning**

This instrument contains a lithium polymer battery. Dispose of lithium cells immediately. Do not disassemble and do not dispose of in fire. Do not mix with the solid waste stream. Spent batteries should be disposed of by a qualified recycler or hazardous materials handler.

Sensor Poisons and Contaminants

Several cleaners, solvents, and lubricants can contaminate and cause permanent damage to sensors. Before using cleaners, solvents, and lubricants in close proximity to the detector sensors, read and adhere to the following caution and table.

⚠ Caution

Use only the following BW Technologies by Honeywell recommended products and procedures:

- **Use water based cleaners.**
- **Use non-alcohol based cleaners.**
- **Clean the exterior with a soft, damp cloth.**
- **Do not use soaps, polishes, or solvents.**

The following table lists common products to avoid using around sensors.

Cleaners and Lubricants	Silicones	Aerosols
Brake cleaners	Silicone cleaners and protectants	Bug repellents and sprays
Lubricants	Silicone based adhesives, sealants, and gels	Lubricants
Rust inhibitors	Hand/body and medicinal creams containing silicone	Rust inhibitors
Window and glass cleaners	Tissues containing silicone	Window and glass cleaners
Dishsoaps	Mold releasing agents	
Citrus based cleaners	Polishes	
Alcohol based cleaners		
Hand sanitizers		
Anionic detergents		
Methanol (fuels and antifreezes)		

Parts of the GasAlertMicro 5/PID/IR

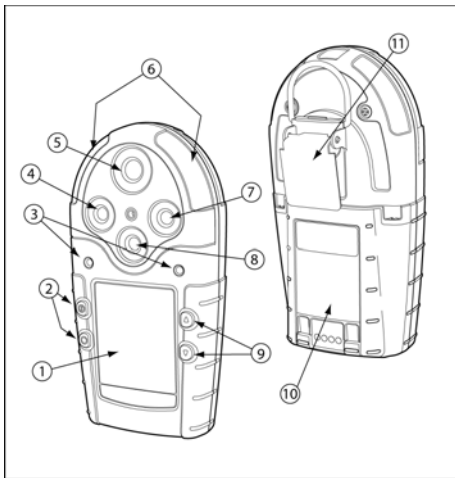





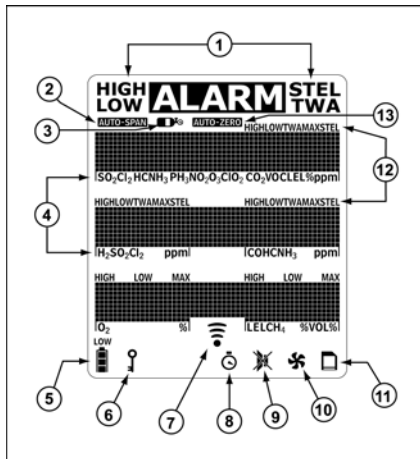











Item	Description
1	Liquid crystal display (LCD)
2	Pushbuttons
3	Audible alarms
4	Toxic 2 sensor
5	Toxic 1/PID sensor (Micro 5 PID) or Toxic 1/IR (CO ₂) sensor (Micro 5 IR)
6	Visual alarm indicators (LEDs)
7	LEL sensor
8	Oxygen sensor
9	Pushbuttons
10	Battery pack
11	Alligator clip

Display Elements



Item	Description
1	Alarm condition
2	Automatically span sensor
3	Gas cylinder
4	Gas identifier bars
5	Battery life indicator
6	Passcode lock
7	Data transmission
8	Clock
9	Stealth mode
10	Optional pump indicator
11	Datalog card indicator (optional)
12	Alarm condition (low, high, TWA, STEL, or multi) or view TWA, STEL and peak (MAX) gas exposures
13	Automatically zero sensor

Pushbutton

Pushbutton	Description
	<ul style="list-style-type: none"> • To activate the detector, press . • To deactivate the detector, press and hold  until the countdown is complete.
	<ul style="list-style-type: none"> • To increment the displayed value or scroll up, press . • To enter the user option menu, press  and  simultaneously and hold until the countdown is complete. • To clear the TWA, STEL, and peak (MAX) gas exposure readings, press  and  simultaneously and hold until the countdown is complete. • To view the date and time, alarm setpoints (TWA, STEL, low, and high) of all sensors, and the LEL correction factor (if applicable), press .
	<ul style="list-style-type: none"> • To decrement the displayed value or scroll down, press . • To initiate calibration and setting alarm setpoints, press  and  simultaneously and hold until the countdown is complete.
	<ul style="list-style-type: none"> • To view the TWA, STEL, and peak (MAX) readings, press . • To acknowledge latched alarms, press .

Connecting the Gas Cylinder to the Detector

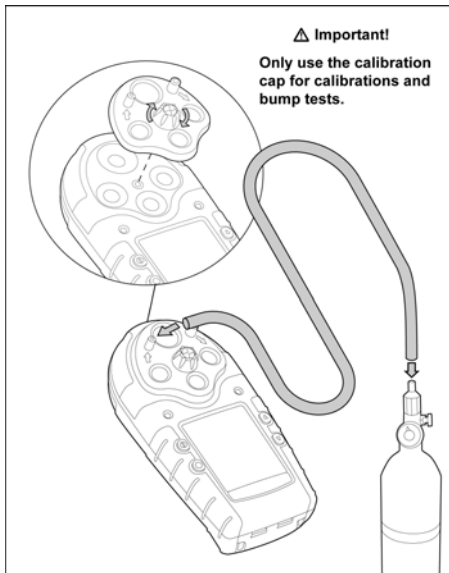

Single Gas Calibration Cap

⚠ Caution

If an O₃ or ClO₂ sensor is located in the Toxic 2 sensor position, a single gas calibration cap must be used to ensure accurate calibration.

Only use the single gas calibration cap during the calibration process.

To calibrate O₃ and ClO₂ sensors using the single gas calibration cap, refer to the following procedures and illustrations.

1. Insert the cap into the Toxic 2 sensor position on the detector. Press firmly until the release tabs click.

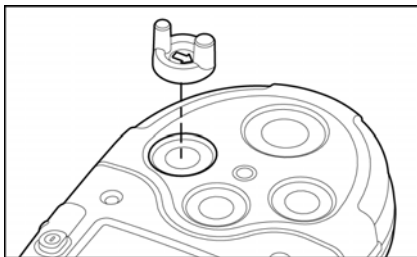

2. Connect the calibration hose to the gas cylinder and to the intake inlet on the cap.

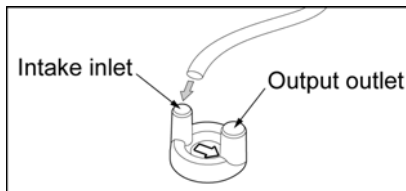

Note

The arrow on the cap indicates the direction of gas flow from intake to outtake.

Removing the Cap

Using your thumb, push forward against both the inlet and outlet simultaneously to remove the cap from the detector.

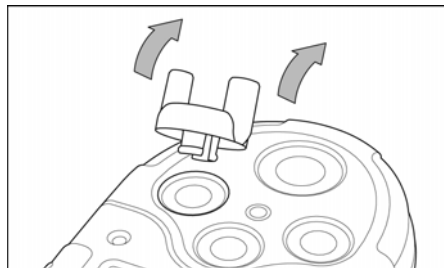

Confined Space Sampling

To measure hazardous gas in a confined space, refer to the following illustration and steps 1-5.

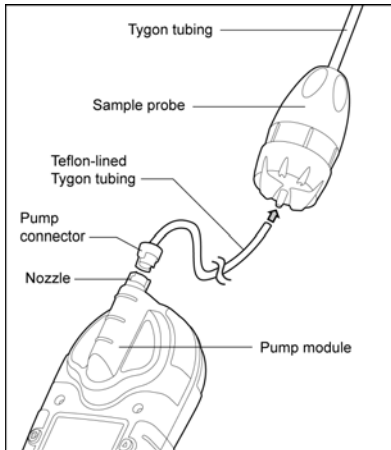

⚠ Warning

To measure hazardous gas in a confined space, the sample probe must be used with the pump module.

⚠ Caution

To prevent the teflon lining inside the Tygon tubing from causing a blockage when connecting it to the sample probe, the end of the tubing must be flared. Refer to steps 2 and 3.

1. Attach the pump connector end of the teflon-lined Tygon tubing to the pump module.
2. Gently insert needle nose pliers into the other end of the teflon-lined Tygon tubing. Using a circular motion, flare the end of the tubing.
3. Connect the flared end of the tubing to the sample probe. Ensure the teflon-lining does not separate from the Tygon tubing, as it will block the tube and generate a pump alarm.
4. Activate the detector. Ensure all connections are secure before sampling.
5. Insert the sample probe into the confined space.



⚠ Warning

Depending upon the length of the tubing and the type of gas in the confined space, allow a minimum of 3 seconds per foot of tubing to ensure the readings stabilize before entering the area.

Example: 50 ft. = 2.5 minutes

Calibration

Calibrate only in a safe area in an atmosphere of 20.9% oxygen.

1. Activate the detector. To enter calibration, press and hold  and  simultaneously. The detector beeps and flashes to the corresponding countdown. The LCD then displays **Starting calibration**.

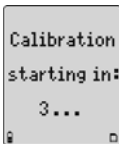

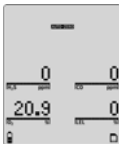

2. **AUTO-ZERO** flashes while the detector zeros all of the sensors (except CO₂) and calibrates the oxygen sensor. If a sensor fails to auto zero, that sensor will bypass the span.

If calibrating a Micro 5 or Micro 5 PID, proceed to step #4.



Step #3 for Micro 5 IR Only



3. The **Zero-CO2?** screen displays. Press  to zero the CO₂ sensor, or press  to bypass.

If  is pressed to zero the CO₂ sensor, the following screens display:

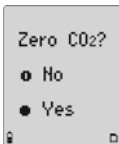
- **Apply CO₂ zero gas now** (nitrogen must be used to zero the CO₂ sensor).
- The **Auto-Zero CO₂** screen displays, and **AUTO-ZERO** flashes.



4. The following three screens display:



- **Apply span gas now to calibrate**
- **or press  to select sensor(s)**
- **or press  to skip calibration**

If none of the buttons are pressed, proceed to step #6.

If  is pressed, proceed to step #5.

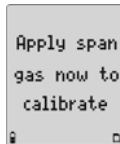
If  is pressed, proceed to the end of step #7.



5. Select which sensor to span. Press  or  to scroll to the required sensor and then press  to select. Sensors must be spanned in the following order:

- Exotics (NH₃, ClO₂, O₃, and CO₂)
- Single gases
- Quad gases (H₂S, CO, O₂ and LEL).

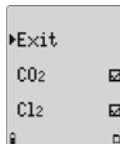

6. Attach the calibration cap and apply gas at a flow rate of 500 ml/min.

 flashes while the detector determines which gas is being applied.

After 30 seconds, **AUTO-SPAN** flashes and a countdown displays while the detector completes the span.

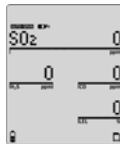

7. When the span is complete, the following three screens display:

- **Calibration successful**
- Press ▲ to apply a new cal gas
- Press ▼ to end span

Repeat steps #4-7 to calibrate the remaining sensors.

The LCD displays the following options:

- Press ○ to set the calibration due dates or press Ⓞ to bypass.

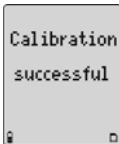

8. Press ▲ or ▼ to change the calibration due date. Press ○ to accept the value and proceed to the next due date. If a sensor fails or does not span, the calibration due date cannot be changed for that sensor.

The LCD displays the following options:

- Press ○ to change the calibration due dates or press Ⓞ to bypass.

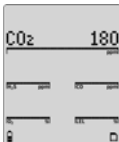

9. Press ▲ or ▼ to change the alarm setpoint. Press ○ to save the value and proceed to the next setpoint.

Define the remaining setpoints. The detector beeps twice when all of the alarm setpoints have been defined or bypassed.

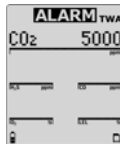

10. When calibration is complete, **Saving calibration** displays.

Note

Only use the calibration cap and single gas calibration cap during calibration and bump tests.

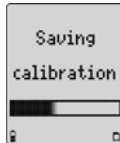

For additional information about performing calibrations and bump tests, refer to the *GasAlertMicro 5/PID/IR User Manual*.

Alarms



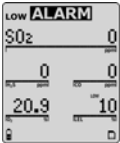
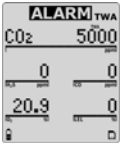
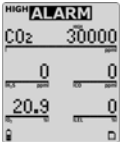
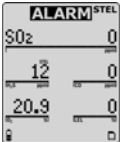

Refer to the following table for information about alarms and corresponding screens. During an alarm condition, the backlight activates and the LCD displays the ambient gas readings.

Alarm	Screen	Alarm	Screen
Low Alarm <ul style="list-style-type: none"> • Fast beep • Slow flash • ALARM and target gas bar flash • Vibrator alarm activates 		TWA Alarm <ul style="list-style-type: none"> • Fast beep • Slow flash • ALARM and target gas bar flash • Vibrator alarm activates 	
High Alarm <ul style="list-style-type: none"> • Constant beep • Fast flash • ALARM and target gas bar flash • Vibrator alarm activates 		STEL Alarm <ul style="list-style-type: none"> • Constant beep • Fast flash • ALARM and target gas bar flash • Vibrator alarm activates 	

GasAlertMicro 5/PID/IR

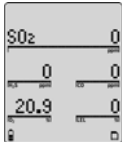
Quick Reference Guide

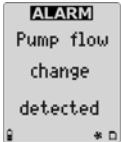
Alarm	Screen	Alarm	Screen
<p>Multi Alarm</p> <ul style="list-style-type: none"> Alternating low and high alarm beep and flash ALARM and target gas bars flash Vibrator alarm activates 		<p>Over Limit (OL) Alarm</p> <ul style="list-style-type: none"> Fast beep and flash ALARM and target gas bar flash Vibrator alarm activates 	
<p>Sensor Alarm</p> <ul style="list-style-type: none"> One beep every 15 seconds FAIL flashes above the failed sensor 		<p>Automatic Deactivation Alarm</p> <ul style="list-style-type: none"> Eight beeps and flashes LOW displays Vibrator alarm temporarily activates Battery depleted screen displays and the detector deactivates 	
<p>Low Battery Alarm</p> <ul style="list-style-type: none"> One beep and two flashes every 25 seconds LOW displays <p>⚠ Caution</p> <p>Charge the battery immediately when a low battery alarm occurs.</p>		<p>Normal Deactivation</p> <ul style="list-style-type: none"> Three beeps and flashes 	

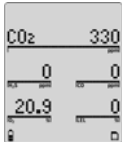
Alarm	Screen	Alarm	Screen
<p>Confidence Beep</p> <ul style="list-style-type: none"> One beep, one flash, and one vibration every 10 seconds <p style="text-align: center;"><i>Note</i></p> <p><i>The Confidence Beep option is automatically disabled during a low battery alarm.</i></p>		<p>Pump Alarm</p> <ul style="list-style-type: none"> Screen flashes: <ul style="list-style-type: none"> Pump flow change detected Check for blocked inlet or press <input type="radio"/> to run a pump test Two fast beeps and alternating flashes Vibrator alarm activates ALARM and  flash 	
<p>MMC Fail Alarm</p> <ul style="list-style-type: none"> One beep every 5 seconds  flashes 			

Note

*If enabled, during an alarm condition the **Latching Alarms** option causes the low and high gas alarms (audible, visual, and vibrator) to persist until the alarm is acknowledged and the gas concentration is below the low alarm setpoint. The alarm can be temporarily deactivated by pressing , but the LCD displays the high peak concentration until the alarm no longer exists. Local regulations may require the **Latching Alarms** option be enabled.*

User Options Menu

To access the user options, press and hold ▲ and ▼ simultaneously until the detector completes the countdown. To scroll through the options press ▲ or ▼. Press ○ to select the option. The following options are available.

Exit: Exits the user options menu.

User Options:

- **Backlight** (backlight): Enables/disables the automatic backlight in low-light conditions.
- **Confibeep** (confidence beep): If enabled, the confidence beep provides continuous confirmation that the detector is operating correctly (audible beep every 10 seconds).
- **Due-lock** (calibration user lockout): If enabled, upon startup a passcode is required to operate a detector that is overdue for calibration.
- **Latch** (latched alarm): Enable to ensure an alarm persists until it is acknowledged (press ○ to acknowledge).
- **Passcode** (passcode protection): Enable to prevent unauthorized personnel from accessing the user options menu, calibration function, and alarm setpoint adjust function.
- **Safe** (safe mode): If enabled, **Safe** displays continuously on the LCD unless an alarm condition occurs.

Sensors:

- **Sens on** (sensor enabled): Enables/disables a sensor (the detector continues to operate if a sensor is disabled).

⚠ Warning

Use extreme caution when disabling a sensor. The disabled sensor cannot detect and alarm against the applicable gas.

- **Span gas:** Define the span gas concentration for each sensor (must match the gas concentration on the gas cylinder).
- **Stel period** (Short Term Exposure Limit): The short term exposure limit (STEL) provides protection for workers from over exposure to high concentrations of gas, and is based on user-defined 5-15 minute intervals.
When the maximum STEL is reached, the detector alarms to notify the worker. Set the STEL period from 5-15 minutes (applicable to toxic sensors only).
- **TWA method** (Time Weighted Average): This option is a safety measure that calculates the accumulated averages of gases to warn the worker when the maximum average is accumulated. Select one of the following options:
 - **OSHA Method:** 8 hour moving average - oldest value (first hour) is replaced by the newest value (ninth hour).
 - **ACGIH Method:** Infinite accumulated average to 8 hours - total accumulation, whether it is 2 hours or 8 hours.
- **Resolution:** Defines the resolution of the gas measurement as either regular or extra (if applicable).

- **%vol CO₂**: Enable to display the carbon dioxide (CO₂) reading as %vol.
- **%vol CH₄**: Enable to display the LEL readings as %vol assuming a methane environment.
- **Correction Factor (%)**: Enter a compensation factor for hydrocarbons other than methane. The factor can only be applied if the LEL sensor has been calibrated with methane (LEL only).
- **Autocal** (automatic oxygen calibration) Enable/disable the detector to automatically calibrate the oxygen sensor during startup.

Logger (Datalogging): Define how often the detector records a datalog sample (once every 1 to 127 seconds).

Clock: Define the date and time for the detector.

Language: Displays the LCD screens in **English**, **Français** (French), **Deutsch** (German), **Español** (Spanish), or **Prtugês** (Portuguese).

Note

The detector is shipped displaying English as the default language.

Maintenance

To maintain the detector in good operating condition, perform the following basic maintenance as required.

- Calibrate, bump test, and inspect the detector on a regular schedule.
- Maintain an operations log of all maintenance, bump tests, calibrations, and alarm events.
- Clean the exterior with a soft damp cloth. Do not use solvents, soaps, or polishes. Refer to [Sensor Poisons and Contaminants on page 4](#).
- Do not immerse the detector in liquids.

Replacing Battery Cells and Packs

⚠ Warning

To avoid personal injury and/or property damage, adhere to the following battery cautions:

- Replace the alkaline cells or rechargeable battery pack immediately when the detector emits a low battery alarm.
- Use only batteries that are recommended by [BW Technologies by Honeywell](#).
- Use only approved alkaline batteries that are properly installed in the battery pack. Refer to [Specifications](#).
- To order lithium battery packs (M5-BAT08/M5-BAT07), contact [BW Technologies by Honeywell](#).

- Charge the batteries and battery packs using only a recommended BW charger. Failure to adhere to this caution can lead to fire and/or explosion.
- The detector must be deactivated to charge the battery pack.
- Do not calibrate the detector immediately after charging is complete.
- Both the lithium battery pack and the alkaline battery pack are user-changeable in hazardous locations, but the alkaline battery cells inside the pack can only be replaced in a safe area that is free of hazardous gas.
- **Warning:** The M5-BAT08 and M5-BAT07 battery packs are equipped with lithium batteries that can present a risk of fire or chemical burn hazard if misused. Do not recharge, disassemble, heat above 212°F (100°C), or incinerate.
- **Warning:** Do not use any other lithium batteries with the GasAlertMicro 5, GasAlertMicro 5 PID, and GasAlertMicro 5 IR detectors. Use of any other cell can cause fire and/or explosion.
- **Warning:** Lithium polymer cells exposed to heat at 266°F (130°C) for 10 minutes can cause fire and/or explosion.
- Dispose of used lithium cells immediately. Do not disassemble and do not dispose of in fire. Do not mix with the solid waste stream. Spent batteries must be disposed of by a qualified recycler or hazardous materials handler.
- Keep lithium cells away from children.

Replacing Alkaline Batteries

Warning

Always deactivate the detector before removing the battery pack. The battery packs are user-changeable in hazardous locations, but the alkaline battery cells inside the pack must be changed in a safe area that is free of hazardous gas.

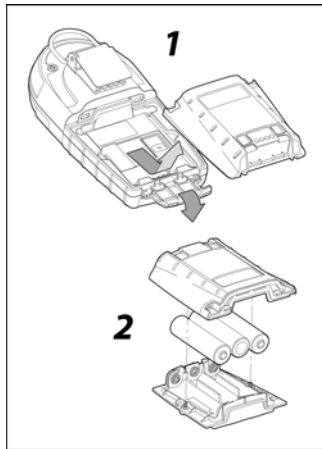

To charge the rechargeable battery pack, refer to the *GasAlertMicro 5/PID/IR Battery Charger User Manual*.

To replace the alkaline batteries, refer to the following procedures and illustration.

1. Open the latch on the bottom of the detector.
2. Remove the battery pack by lifting the bottom of the pack upward from the detector.
3. On the battery pack, unscrew the two captive screws and open.
4. Replace the three alkaline battery cells.
5. Replace the cover and reinsert the two captive screws.
6. Replace the battery pack on the detector.
7. Close the latch.

Replacing Lithium Battery Packs

⚠ Warning

Do not disassemble lithium battery pack. Read and adhere to the cautions in [Replacing Battery Cells and Packs](#).

To replace the lithium battery pack, refer to the following illustration and steps 1-4.

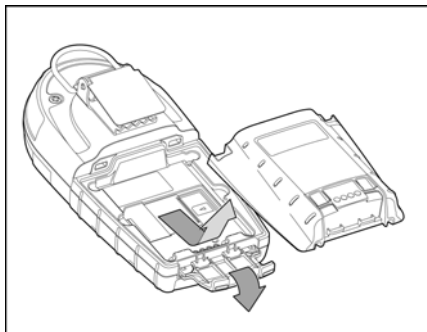

1. Open the latch on the bottom of the detector.
2. Remove the battery pack by lifting the bottom of the pack upward from the detector.
3. Replace the battery pack with a fully charged lithium battery pack.
4. Close the latch.

Replacing a Sensor or Sensor Filter

To replace a sensor or sensor filter, refer to the following illustration, table, and steps 1-7.

⚠ Warning

To avoid personal injury and/or property damage, only use sensors that are specifically designed for the detector.

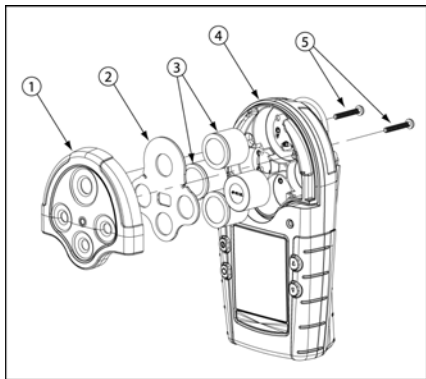

Note

Detectors that are configured for 1, 2, or 3 gases may contain a dummy sensor in one of the four sensor locations.

Item	Description
1	Sensor cover
2	Sensor filter
3	Sensors
4	Detector
5	Machine screws (2)

1. Deactivate the detector.
2. Remove the two machine screws on the rear shell and then remove the sensor cover or pump module cover.
3. Remove the sensor filter and/or sensor(s).
4. Insert the new filter and/or sensor(s). Ensure the sensor posts are aligned correctly.
5. Re-assemble the detector.
6. If the sensor is replaced with a different type of sensor (SO₂ to an H₂S), the detector must be reconfigured. Refer to "Sensors" in the "Tech Mode" section of the *GasAlertMicro 5/PID/IR User Manual*.

7. Activate the detector and then calibrate the new sensor(s). Refer to [Calibration](#).

Replacing the Pump Filter

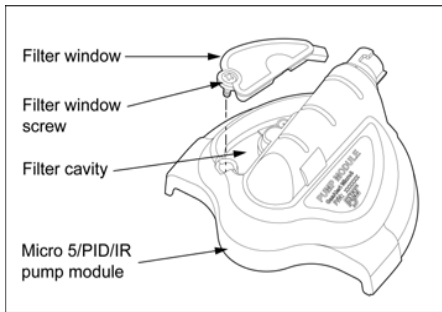

1. Deactivate the detector.
2. Remove the filter window screw and the filter window.
3. Remove the old filter.
4. **Important!** Ensure the filter cavity and filter window are clean and free of debris. Insert a new filter.
5. Replace the filter window and screw.

Replacing the Pump Nozzle

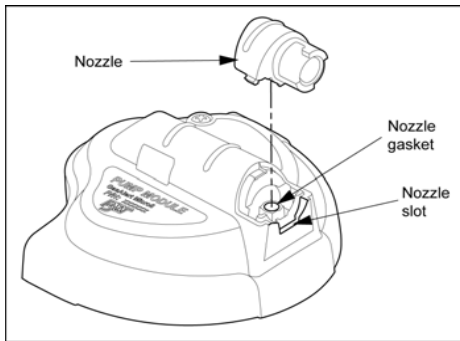

Note

If the nozzle is damaged, replace it immediately to ensure accurate pump flow.

1. Deactivate the detector.
2. Gently insert a medium sized flathead screw driver into the nozzle slot. Lift and remove the damaged nozzle.
3. Insert the new nozzle. Ensure the nozzle post inserts correctly into the nozzle gasket.

Specifications

Instrument dimensions: 14.5 x 7.4 x 3.8 cm
(5.7 x 2.9 x 1.5 in.)

Weight: 370 g (13.1 oz.)

Operating and storage conditions:

Temperature:

VOC: -10°C to +40°C (14°F to +104°F)

Other gases: -20°C to +50°C (-4°F to +122°F)

Combustible gas sensor: Certified by CSA International to $\pm 3\%$
LEL accuracy from -10°C to +40°C (4°F to 104°F)

Operating humidity:

O₂: 0% to 99% relative humidity (non-condensing)

VOC: 0% to 95% relative humidity (non-condensing)

Combustibles: 5% to 95% relative humidity (non-condensing)

Cl₂: 10% to 95% relative humidity (non-condensing)

HCN, ClO₂: 15% to 90% relative humidity (non-condensing)

Other gases: 15% to 90% relative humidity (non-condensing)

Pressure: 95 to 110 kPa

Dust and moisture ingress: IP65/66

Alarm setpoints: May vary by region and are user-defined

Detection range:

O₂: 0 - 30.0% vol. (0.1% vol. increments)

CO: 0 - 999 ppm (1 ppm increments)

CO (TwinTox sensor): 0 - 500 ppm (1 ppm increments)

H₂S: 0 - 500 ppm (1 ppm increments)

H₂S TwinTox sensor): 0 - 500 ppm (1 ppm increments)

Combustible (LEL): 0 - 100% LEL (1% LEL increments) or
0 - 5.0% v/v methane; certified by CSA International to C22.2
No. 152 and ISA 12.13.01 within 0 - 60% or 3.0% v/v methane
PH₃: 0 - 5.0 ppm (0.1 ppm increments)

SO₂: 0 - 150 ppm (1 ppm increments)

Cl₂: 0 - 50.0 ppm (0.1 ppm increments)

NH₃: 0 - 100 ppm (1 ppm increments)

NO₂: 0 - 99.9 ppm (0.1 ppm increments)

HCN: 0 - 30.0 ppm (0.1 ppm increments)

ClO₂: 0 - 1.00 ppm (1.00 ppm increments)

O₃: 0 - 100 ppm (0.01 ppm increments)

VOC: 0 - 1000 ppm (1.0 ppm increments)

CO₂ IR: 0 - 50,000 ppm (50 ppm increments) or 0-5.0% v/v CO₂
(Sensors not certified for use with the GasAlertMicro 5 IR: ClO₂,

HCN, NO₂, PH₃, Cl₂)

Sensor type:

H₂S/CO: Twin plug-in electrochemical cell

Combustibles: Plug-in catalytic bead

VOC: Photoionization detector (PID)

CO₂: IR detector

Other gases: Single plug-in electrochemical cell

O₂ measuring principle: Capillary controlled concentration sensor

Alarm conditions: TWA alarm, STEL alarm, low alarm, high alarm, multi alarm, over limit (OL) alarm, sensor alarm, pump alarm, MMC/SD fail alarm, low battery alarm, confidence beep, automatic deactivation alarm

Audible alarm: 95 dB at 0.3 m (1 ft.) variable pulsed dual beepers

Visual alarm: Dual red light-emitting diodes (LEDs)

Display: Alphanumeric liquid crystal display (LCD)

Backlight: Activates briefly during startup, when there is insufficient light to view the display (if enabled), and during alarm conditions

Self-test: Initiated during activation

Calibration: Automatic zero and automatic span

Oxygen sensor: Automatic span during startup (if enabled)

User field options: Confidence beep, latching low and high alarms, passcode protection, enable/disable safe display mode, combustible sensor measurement, sensor enable/disable, language selection, enable/disable automatic O₂ calibration, set span concentration values, set STEL calculation period, set TWA method, gas measurement resolution, enable/disable automatic backlight, adjust clock/calendar, set datalogging rate (datalog models only), CO₂ sensor measurement

Datalog Models:

Approved for GasAlertMicro 5 and Micro 5 PID Models:

Delkin 128 MB SD card and 64 MB Unigen SD card

Approved for GasAlertMicro 5 IR Models: Delkin 128 MB MMC, Delkin 128 MB SD card, Transcend 128 MB SD, and 64 MB Unigen SD card

Battery operating time:

Toxic, O₂, and LEL sensors: Three alkaline cells or one lithium battery pack at 20°C / 68°F provides 20 hours operating runtime

Toxic, O₂, LEL, and PID sensors: Three alkaline cells or one lithium battery pack at 20°C / 68°F provides 15 hours operating runtime

Toxic, O₂, LEL, and CO₂ sensors: Three alkaline cells or one lithium battery pack at 20°C / 68°F provides 15 hours operating runtime

Approved Batteries:

Approved batteries for GasAlertMicro 5, GasAlertMicro 5 PID, and GasAlertMicro 5 IR product: Alkaline (M5-BAT02) and lithium-ion polymer (M5-BAT08 and M5-BAT07), as per standards EN 60079-11, EN 60079-0, UL913, CSA C22.2 No. 157

Rechargeable battery (M5-BAT08) **Temperature code**

Lithium polymer -20°C ≤ Ta ≤ +50°C T4

Alkaline batteries:

Duracell MN1500 -20°C ≤ Ta ≤ +50°C T4 (129.9°C)

Energizer E91VP -20°C ≤ Ta ≤ +50°C T3C (135.3°C)

Battery charger: GasAlertMicro 5/PID/IR battery charger

First-time charge: 4 hours per battery pack / lithium 6 hours

Normal charge: 3-4 hours per battery pack / lithium 6 hours

Warranty: 2 years including sensors (1 year NH₃ sensor and PID lamp)

GasAlertMicro 5/PID/IR

Quick Reference Guide

Year of manufacture: The detector's year of manufacture is determined from the serial number. The second and third number after the first letter determines the year of manufacture. E.g., H309-000001 = 2009 year of manufacture

Approvals:

GasAlertMicro 5 and GasAlertMicro 5 PID (Zone 0):

Approved by CSA to both U.S. and Canadian Standards

Standards: CAN/CSA C22.2 No. 157 and C22.2 152

ANSI/UL – 913 and ANSI/ISA – S12.13 Part 1

CSA Class I, Division 1, Group A, B, C, and D
Class 1, Zone 0, Group IIC

ATEX CE 0539 (Ex) II 1 G Ga Ex ia IIC T4
KEMA 06 ATEX 0206X

IECEX EN 60079-0, EN 60079-11, EN 60079-26
Ga Ex ia IIC IECEX CSA 06.0011X
IEC 60079-0, IEC 60079-11, IEC 60079-26

ABS Type Approved: VA-348169-X

GasAlertMicro 5 IR (Zone 1):

Approved by CSA to both U.S. and Canadian Standards

Standards: CAN/CSA C22.2 No. 157 and C22.2 152

ANSI/UL – 913 and ANSI/ISA – S12.13 Part 1

CSA Class I, Division 1, Group A, B, C, and D
Class 1, Zone 1, Group IIC

ATEX CE 0539 (Ex) II 2 G Ex d ia IIC
KEMA 06 ATEX 0206X

IECEX EN60079-0, EN 60079-1, EN 60079-11
Ex d ia IIC IECEX CSA 06.0011X
IEC 60079-0, IEC 60079-1, IEC 60079-11

This equipment has been tested and found to comply with the limits for a Class B digital device, pursuant to Part 15 of the FCC Rules and ICES-003 Canadian EMI requirements. These limits are designed to provide reasonable protection against harmful interference in a residential installation. This equipment generates, uses and can radiate radio frequency energy and, if not installed and used in accordance with the instructions, may cause harmful interference to radio communications. However, there is no guarantee that interference will not occur in a particular installation. If this equipment does cause harmful interference to radio or television reception, which can be determined by turning the equipment off and on, the user is encouraged to try to correct the interference by one or more of the following measures:

- Reorient or relocate the receiving antenna.
- Increase the separation between the equipment and receiver.
- Connect the equipment into an outlet on a circuit different from that to which the receiver is connected.
- Consult the dealer or an experienced radio/TV technician for help.

Wear yellow. Work safe.

iERP: 128900

D6258/1 [English]

© BW Technologies 2009. All rights reserved.

Which pump do I have?

The best way to differentiate the Generation 2 pump from the Generation 1 pump is the inline filter that is visible on the Generation 2 pump on the left-hand side. The product labels are also different.

Generation 1 Pump



Part number 116885 (yellow) and 118933 (black)

Operation Information for the Generation 1 pump

Using the sintered filter

For temperatures -10°C to +0°C (14°F to 32°F)

The maximum tube length when using the metallic sintered filter is 10 ft. (3 m).

For temperatures 0°C to +50°C (32°F to 122°F)

The maximum tube length when using the metallic sintered filter is 30 ft. (9.1 m).

Using the sample probe

For temperatures -10°C to +0°C (14°F to 32°F)

The maximum tube length when using the sample probe is 10 ft. (3 m).

⚠ Warning

When using the sample probe at -10°C to +0°C (14°F to 32°F), keep the sample probe in your hand .

For temperatures 0°C to +50°C (32°F to 122°F)

The maximum tube length when using the sample probe is 10 ft. (3 m).

Generation 2 Pump



Part number 130916 (yellow) and 130917 (black)

Operation Information for the Generation 2 pump

Using the sintered filter

For temperatures -20°C to +50°C (-4°F to 122°F)

The maximum tube length when using the metallic sintered filter is 67 ft. (20 m).

Using the sample probe

For temperatures -20°C to +50°C (-4°F to 122°F)

The maximum tube length when using the sample probe is 10 ft. (3 m)

see over for more important pump information

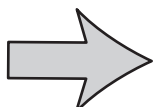

Information for both Generation 2 and Generation 1 pumps

⚠ Warning

Do not upgrade your X5 Series unit unless you have contacted BW Technologies by Honeywell first.

The following information has been changed for the GasAlertMicro 5 Series/X5 Series.

Quick Reference Guide (128900 D6258/1)

Proper Pump Operation

When using the pump module, attach it and the pump accessories prior to activating the detector.

⚠ Warning

If the pump module is installed on the detector, the following three things must occur during start-up. **If any one of the conditions below does not occur, discontinue use of the detector and contact BW Technologies by Honeywell immediately.**

- The detector prompts for a pump test during start-up
- The pump module passes the pump test at start-up when the pump inlet or sample chain inlet is blocked
- The 🌀 icon displays on the LCD

Pump Features

The sections regarding Replacing the Pump Filter and Replacing the Pump Nozzle are for the Generation 2 pump. To replace those components, refer to Pump Module Auxiliary Filter Instruction Card.

⚠ Warning

To ensure accurate gas detection, the sensors must be calibrated immediately when the pump module is replaced by the diffusion cap and vice versa.

⚠ Caution

A demand flow regulator must be used to manually calibrate the GasAlertMicro 5/PID/IR detector when the pump module is installed.

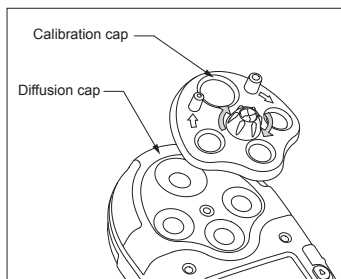

Note

The calibration cap is designed for use with the diffusion cap only. It cannot be used with the pump module.

Pump Alarm

The external pump draws air over the sensors continually. If the pump stops operating or becomes blocked, the detector activates the pump alarm and the pump alarm latches. The following screens display.

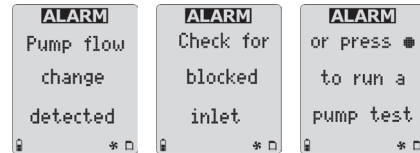

⚠ Caution

Ensure the blockage is cleared before pressing to acknowledge the latched pump alarm.

When is pressed, the detector automatically launches a pump test to reset the pump module.

Refer to Pump Test in the GasAlertMicro 5/PID/IR User Manual for more information. If the pump test is successful, the detector returns to normal operation, otherwise the pump alarm continues. If the pump alarm persists, refer to the Pump Operation section in Troubleshooting in the GasAlertMicro 5/PID/IR User Manual.